

# Residential Skylights & SUN TUNNEL® Skylights



# Contents

## Inspiration

- 3 Why Skylights?
- 4 Design Consultation
- 5 VELUX Installers Program
- 6 A Skylight for Every Ceiling
- 8 What is your Roof Pitch?
- 10 Installation Types
- 11 VELUX Installers Program
- 12 It's not just any Skylight
- 14 The Smart Skylight
- 16 Choosing the Right Glass
- 18 Skylight Glass Options
- 20 VELUX Sustainability

## Product Information

- 21 The Best Skylight to Perform
- 22 Choosing the Right Flashing
- 23 Flashing Options
- 24 Deck & Curb Mounted Models
- 26 Deck Mounted Roof Windows
- 28 In Stock FCM
- 29 Custom FCM
- 30 Curb Mounted GSM - Skymax Custom Series
- 31 Flat Roof Skylights
- 32 Curved Glass Skylight
- 34 Skylight Accessories
- 36 SUN TUNNEL® Skylight
- 38 SUN TUNNEL® Models
- 40 VELUX Blind Collection
- 41 Blind Options
- 42 VELUX Blind Codes
- 42 VELUX Blind Collection

## Sizes

- 45 Deck Mounted Models
- 46 Deck Mounted Roof Window Models
- 47 Curb Mounted Models
- 48 Custom FCM Sizes
- 49 Flat Roof Models
- 50 Warranty
- 51 Energy Star®

# Why Skylights?

Getting the right amount of daylight is essential for our health and well-being; it improves our mood and fights Seasonal Affective Disorder (SAD). Skylights can deliver daylight deep into the room and greatly reduces the need for artificial light lowering electricity costs. Why settle for dark spots in your home when you can add daylight, save money and create a healthier environment for your family.



## Daylight

A skylight delivers 2 times the amount of daylight than a wall window and can brighten the interior of your home.

Daylight helps to balance our Circadian Rhythm, keeping our body's natural 24-hour clock in tune. Lack of daylight may cause sleep disturbance, stress, obesity, fatigue and depression.

Save money! With more daylight, you will reduce your dependence on electrical lighting.



## Fresh Air

3 times a day keeps the doctor away! Open your home to fresh and cleaner air for a healthier home.

Maximize the chimney effect, opening your skylight at the highest point in your home allows you to release hot, stale air trapped at the top of a ceiling.

Reduce dependency on air conditioning and rely on night time cooling, saving you money!



## A statement for any room

Enjoy the privacy and beautiful sky views.

Create a beautiful architectural feature in your home making you the envy of the neighbourhood.

Experience your home in a whole new and well-lit light.

**Looking for room by room  
inspiration?**

Find your room and download  
our eBook series at [velux.ca](http://velux.ca)

# Virtual Design Consultation

---

## Book your Free 30-Minute Online Skylight Planning Appointment

Let us help you transform your space into your favourite place! Whether you are replacing your skylight, building a new home, or adding a new skylight, we can help jump-start your daylighting project!

Our VELUX Daylight Experts can help you determine which product best fits your needs and connect you with a VELUX Certified Installer.

Our virtual planning consultation lasts about 30-minutes, so you can attend the online appointment right from the comfort of your home and show us exactly where you would like to add or replace your skylight.



# VELUX Installers Program

---



Bringing you a cutting-edge No Leak skylight system is only part of why VELUX is the most trusted brand world-wide. We know that the installation is an essential part of our No Leak system, that is why VELUX invests in our VELUX Installers Program.

We train and certify companies across Canada to install our No Leak Skylight System, giving you peace of mind when adding or replacing your skylight.

To find a certified member of our VELUX Installers Program near you go to [velux.ca](http://velux.ca)



# A Skylight for Every Ceiling

Skylights can be installed in any type of ceiling and roof construction. A common misconception is that a skylight is only suitable for vaulted ceilings. In fact, skylights can be installed on a pitched roof with a flat interior ceiling and they can also be installed in flat roof structures.

Flat ceiling

Flat ceiling

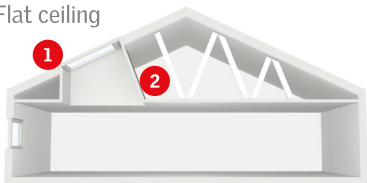

## Here's how it works.

Pitched roof and flat interior ceiling:

- 1** Skylight is installed on the exterior of the roof and tied into the roof system using our 3 layers of water protection.
- 2** An insulated shaft is built to connect the opening on the roof to the flat ceiling. The skylight on the inside is tied into the air barrier of your home to prevent condensation. Your installer will discuss how the shaft can be flared to maximize the light and create drama in your home.

**NOTE:** This installation can take 1-5 days depending on how deep the shaft is and how it is finished.



## Other ceiling types

Flat Roof



Vaulted Ceiling



SUN TUNNEL®



## Looking for an Installer?

We recommend that you contact a member of our VELUX Installers Program for a consultation, most offer free estimates. During your consultation with a member of the VELUX Installers Program the installer will examine your roof structure, attic and interior space. They can recommend the right number of skylights for your home and the right installation method.

Visit [velux.ca](https://www.velux.ca), tell us about your project and we will connect you with the right installer in your area.

# What is your Roof Pitch?



In order to determine the best skylight and installation options for you, you or your installer will need to first determine your roof's pitch. Not sure how to determine your roof pitch?

The roof pitch is the angle of your roof, and its calculated by the number of inches it rises vertically for every 12" it extends horizontally. This angle is measured by placing a pitch-gauge directly on the roof and taking an accurate reading.

Download our VELUX Roof pitch app from the app store for an accurate roof pitch reading.



Roof Pitch

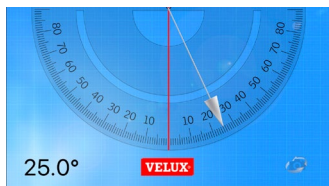





Why is this important? This calculation is important because each of VELUX’s skylights and flashing kits are engineered with specific pitch requirements to ensure the best skylight performance by effectively draining water off. Its just one more way to help ensure your skylight won’t leak!

Here is a simple guide to help you determine which installation method is best for your roof. Please refer to the specific product model to confirm roofing pitch.

Roof pitch	Recommended products
3:12 or greater	Deck Mounted, Roof Window, Curb Mounted
Low slope (3:12 and below)	Curb Mounted or Flat Roof Skylights
Flat roof	Flat Roof Skylights or Curb Mounted
Long shaft or tube runs or Interior spaces	SUN TUNNEL®



# Installation Types

---



## Deck Mounted, Curb Mounted and SUN TUNNEL®

When it comes to skylights, there are three different types of installation methods. To know which installation is right for your home, a skylight installer or roofer will evaluate the home's roof pitch, roofing material, ceiling type and whether it is a replacement job or a new cut-in. Regardless of the installation method, you're installing the same well engineered product that delivers the No Leak Promise, while bringing in plenty of natural light.

## 1 Deck Mounted Skylights



Deck mounted skylights allow for your skylight to have a low profile on your roof and create an energy-efficient installation. With this installation, your skylight is nailed directly to the roof deck. Deck mounted skylights are ideal for new construction, new cut-in skylights and replacements. Minimum roof pitch is 3:12.

---

## 2 Curb Mounted Skylights



Curb mounted skylights are the most common installation preference in low-pitch or flat roof solutions. The "curb" is a frame built mostly by two-by-fours, that are site built to the roof. The skylight is then installed on top of the curb. Imagine it as a shoe box: the curb is the box and the skylight is the box lid. Minimum roof pitch is 0:12, however we recommend a 5° slope for water shed.

---

## 3 SUN TUNNEL® Skylights

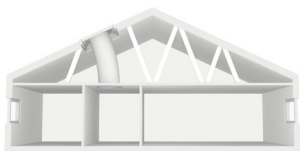

The SUN TUNNEL® skylight's highly reflective and cylinder shape fits between ceiling supports, allowing light to travel from your roof down to the space below. The SUN TUNNEL® is a nonintrusive installation and the tube fits between the ceiling joist and trusses. Installation can be completed in as little as 3 hours.

---

# It's not just any Skylight; it's a **VELUX**!

- ✓ World's leader and most trusted skylight provider.
- ✓ Industry leading quality, engineering and innovation.
- ✓ Most advanced and diverse product offering.
- ✓ Tested to perform in the harshest climates around the world.

VELUX's three patented layers of water protection work seamlessly with your roof to ensure a leak proof installation.



- 1 Pre-attached deck seal** provides a direct seal between the frame and roof deck for a leak-proof installation.



- 2 Adhesive underlayment** for secondary water protection against the harshest weather conditions.

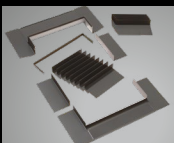

- 3 Engineered flashing** is easy to install and primary defense against the elements.



# The Smart Skylight

## A skylight that thinks for itself

What is a smart skylight? It's not just a skylight that is remote or phone controlled and automatically closes when it rains. A smart skylight is one that compares the outside environment to the indoor air quality and guides the user to create a healthier, more comfortable home. Now that's smart skylight technology!

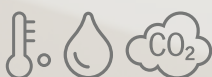

### Daily ventilation

Smart sensors (temperature, humidity, CO2) control your VELUX skylights to ensure a healthier indoor climate by automatically ventilating 2-3 times a day.



### 3 times a day keeps the doctor away

Depending on local weather conditions, the system will air out three times a day, for a healthier home.



### Smart heat protection

Pro-actively closes VELUX blinds based on local weather forecast information.

## The Smart Skylight is as easy as 1-2-3!



**1** Solar Powered or Electric Venting Skylight (VSS/VSE/VCS/VCE)

**2** Solar Powered Blind (optional) (FSCH/FSLH/FSCC /FSLC)

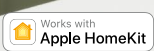



# VELUX ACTIVE

Smart sensor-based operation of your VELUX skylights and blinds.

with  
**NETATMO**



### Stay in control

Operate your VELUX skylights and blinds from your smart phone.



### Say the word

Use voice control assistants to operate your VELUX skylights and blinds.



### Easy departure

Put your VELUX ACTIVE products in safe mode with just one tap.

## 3 VELUX ACTIVE with NETATMO Starter Kit (KIX 300)



# Choosing the Right Glass

---

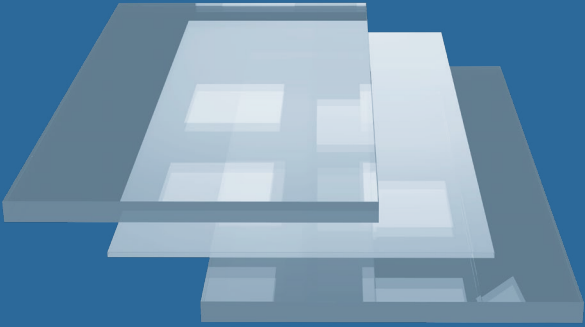

## Energy Skylight Series

Looking for greater energy efficiency, VELUX has the widest selection of in stock Energy Glass options. VELUX offers Energy Star® certified skylights and the VELUX Energy Series, delivering the most energy efficient glass options in the industry.



**VELUX**  
is Canada's leading  
manufacture with the  
most Energy Star®  
certified skylights  
as verified by  
Natural Resources  
Canada

## VELUX Glass

VELUX glass has an advanced triple Low-E protective coating, dual sealed and injected with Argon gas that provides maximum daylight and heat control for year-round comfort and energy savings. All glass offers some degree of protection from heat loss & gain, fading and sound.

---



Laminated glass with Neat® coating (04/29 codes)

Tempered glass (05/30-codes)

## Benefits of Laminated Glass with Neat® coating

Silicon dioxide makes Neat® glass a smoother surface allowing for water to disperse evenly and evaporate quickly reducing water spots.



### Clean

Neat® coating smooths glass surface dispersing water evenly, removing dirt quickly and reduce water spots.



### Safe

Laminated layer prevents glass from shattering into pieces when cracked.



### Quiet

Reduce outside noise by up to 25% more than standard double pane glass and up to 50% more than a plastic dome skylight.



### Hail warranty\*



10-year hail warranty on laminated glass with Neat® coating on cracking or breakage due to hail.

**FACT**

### VELUX inside information

Plastic skylights are poorly insulated and not recommended for Canadian residential applications.

# Skylight Glass Options

Made for <b>Comfort</b>	<b>Glass</b>	<b>Glass Code</b>
	<b>Basic Comfort: Tempered Glass</b>	<b>05</b>
	<b>Benefits</b>	
Made for <b>Better Comfort</b>	<b>Glass</b>	<b>Glass Code</b>
	<b>CleanComfortPlus: Laminated Glass</b>	<b>04</b> 
	<b>Benefits</b>	
Made for <b>Energy Experience</b>	<b>Glass</b>	<b>Glass Code</b>
	<b>Energy i89: Laminated Glass</b>	<b>89</b> 
	<b>Benefits</b>	
	<b>Glass</b>	<b>Glass Code</b>
Made for <b>Energy Experience</b>	<b>Triple pane laminated</b>	<b>29</b> 
	<b>Benefits</b>	

- Exterior and interior tempered pane ideal for in-reach skylights.
- Advanced triple Low-E protective coating and Argon gas filled.

- Exterior tempered glass with Neat® coating for a Clean, Quiet and Safe glass.
- Interior laminated pane for added safety, efficiency, and UV protection.
- 10-year hail warranty.
- Advanced triple Low-E protective coating and Argon gas filled.

- Maximum energy efficiency and thermal performance.
- Interior laminated pane has Low-E coatings applied on two surfaces for enhanced energy efficiency.
- Exterior tempered pane has Neat® coating for a Clean, Quiet and Safe glass.
- 10-year hail warranty.
- Advanced triple Low-E protective coating and Argon gas filled.
- **Meets Vancouver building code.**

- Exterior 2 panes are tempered glass.
- Inner pane is laminated glass.
- Exterior tempered glass with Neat® coating for a Clean, Quiet and Safe glass.
- 10-year hail warranty.
- Advanced triple Low-E protective coating and Argon gas filled.
- **Meets Vancouver building code.**

Glass	Glass Code
-------	------------

**Triple pane**

30



Benefits
----------

- 3 layers of tempered safety glass.
- Protects against fade-causing UV rays.
- High energy efficiency and thermal performance.
- 10-year hail warranty.
- Advanced triple Low-E protective coating and Argon gas filled.

Glass	Glass Code
-------	------------

**Triple pane laminated  
(Deck Mounted Roof  
Window)**

66



Benefits
----------

- Exterior 2 panes are heat strengthened and toughened float glass.
- Sound insulating laminate on inner pane.
- Two internal surfaces with extra heat insulation coatings.
- Argon gas filled.
- Easy to clean and anti-dew coatings on exterior surface.

Glass	Glass Code
-------	------------

**ComfortPlus**

73



Benefits
----------

- Double pane.
- Inner glass pane, laminated with 2 x 3 mm float glass.
- Low-E on inner pane.
- Outer pane is 4 mm float glass.
- Argon gas filled.

Glass	Glass Code
-------	------------

**Triple pane  
(Flat Roof Skylight)**

25



Benefits
----------

- Triple pane.
- Insulated glass unit with inner laminated glass pane for safety.
- Unique window construction with a slim frame and invisible sash.
- Low-E on inner pane.
- Argon gas filled.

■ Laminated glass (04 code) is required to meet most building codes in overhead applications.

\*Hail warranty is subject to certain conditions.

Other glazings available call VELUX for more information.



# VELUX Sustainability

---



## Our Goal **Lifetime Carbon Neutral** by 2041

We are proud to lead the industry for our Sustainability Strategy 2030, which sets an ambitious goal of becoming Lifetime Carbon Neutral by our 100th Anniversary.





Why lifetime carbon neutral?

This is the first step to achieving our Sustainability Strategy 2030 targets. It determines how we make our company – our organization, our products, and our future value chain – more sustainable to create a better future for generations to come.

**It's Our Nature.**

# The Best Skylight to Perform

Knowing what room, the skylight is going into and what you want to achieve is essential to a successful skylight installation or upgrade. Here is a simple guide to help you choose the best skylight for your home.

Tip	If in a high humidity area consider at least one programmable model.	For areas you are looking to add more natural light, choose a fixed skylight.
Rooms		
Needs		

## The Stack effect

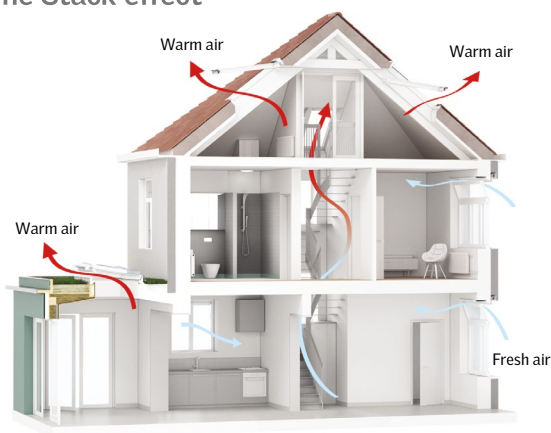

# Choosing the Right Flashing



## The No Leak Skylight™

- No Leak Promise • No Worries



VELUX Engineered flashing systems are designed to shed water without relying on sealants that can break down over time. Only the VELUX No Leak Skylight™ has 3 patented layers of water protection to protect against the harshest weather conditions providing a leak-proof and worry free installation.

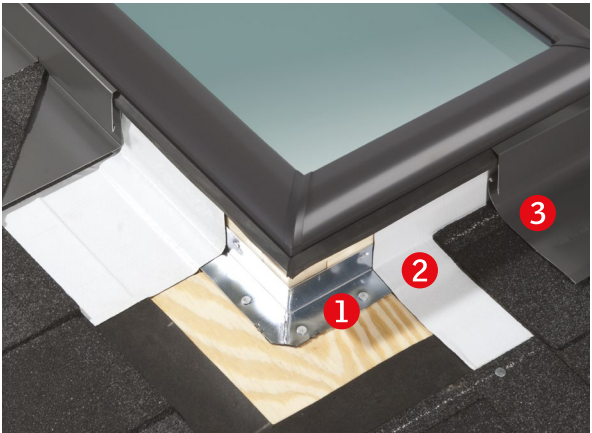



# Flashing Options

---



## **EDL/ECL – Shingles/shakes**

Step flashing pieces interweave with roofing material for proper water drainage.

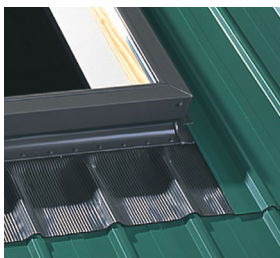

## **EDM – Metal roof flashing**

Flashing pieces interlock with sheet metal roofing material for a weather tight installation (For Deck Mounted Skylights).



## **EDW/ECW – High profile flashing**

Flashing kit for high profile roofing materials such as concrete tiles, Spanish tiles, cedar shakes, metal tile etc.



## **ECB – Flat/Low slope flashing**

Used with site-built curb on low-slope roofs (For Deck Mounted Skylights).



## **EKL/EKW – Combi flashing**

Used to install multiple skylights in groups for dramatic installations (For Deck Mounted Skylights).

# Deck & Curb Mounted Models

## Overhead applications



Recommended for high humidity areas such as kitchens and bathrooms.



### VSS/VCS – Solar Powered Venting Skylight

Requires no wiring making for an easy and cost effective installation that does not require an electrician.

Fully functional regardless of time of day or direction faced, reducing energy consumption and costs.

Package includes simple remote control, insect screen and acoustic rain sensor that automatically closes the skylight in inclement weather.

Engineered flashing kit sold separately.

For size options see page 40-41.



Recommended for high humidity areas such as kitchens and bathrooms.



### VSE/VCE – Electric Venting Skylight

Benefits and package identical to VSS/VCS Solar Powered model with exception of solar panel replaced by single hard wire that connects to a standard junction box.

Recommended to purchase battery back-up.

Engineered flashing kit sold separately.

For size options see page 40-41.



## In-reach applications



Recommended for high humidity areas such as kitchens and bathrooms.

### **VS/VCM** – Manual Venting Skylight

Opens and closes manually.

Includes: insect screen, operator hook and crank handle.  
Control rods are available and sold separately.

Engineered flashing kit sold separately.

For size options see page 40-41.

For other in-reach options see Roof Windows on page 18.

---

## Fixed non-opening applications



Ideal for visually expanding dark areas with daylight and sky views.



### **FS/FCM** – Fixed Skylight

Offers the greatest glass area for bringing in abundant natural light.

Engineered flashing kit sold separately.

Custom size fixed curb mounted skylights (FCM) available.  
Call for details.

For size options see page 40-41.

---

# Deck Mounted Roof Windows

## Triple Pane Roof Window

Easy to clean coating that repels dust and debris.

Enhanced energy efficiency and anti-dew coating.

Laminated safety glass prevents shattered glass from falling in case of breakage.



## GXL – Roof access window



Frame is pine wood, pre-painted white and treated with anti-fungal to ensure longevity.

Easy roof access for roof repairs, maintenance, emergency and Egress.

Can be installed as left hinged or right hinged roof access and window.

Locking device that keeps sash in open position and ventilation flap.

Optional insect screen and blinds available and sold separately.

Available in varnished pine and polyurethane. See page 43 for sizes.

Step flashing and underlayment sold separately.

**Available in Triple Pane for enhanced energy efficiency.**

## GGL – Centre pivot roof window

Frame is pine wood, pre-painted white and treated with anti-fungal to ensure longevity.

The window swivels 180° in its frame for easy and safe cleaning. Ventilation flap opens for limited ventilation.

Optional insect screen and blinds available and sold separately.

Available in varnished pine and polyurethane.

Step flashing and underlayment sold separately.

See page 43 for sizes.

**Available in Triple Pane for enhanced energy efficiency.**



## GPL – Top hinged roof window

Frame is pine wood, pre-painted white and treated with anti-fungal to ensure longevity.

Opens to a 45° angle to satisfy Egress requirements for emergency escape (check local building code).

Ventilation flap opens for limited ventilation.

Optional insect screen and blinds available.

Available in varnished pine and polyurethane.

Step flashing and underlayment sold separately.

See page 43 for sizes.

**Available in Triple Pane for enhanced energy efficiency.**



## GDL – Balcony roof window

Dual-sash operation: Top opens for ventilation and bottom opens outward to create a balcony. Ventilation flap included.

Top sash rotates inward for easy glass cleaning from inside.

Optional insect screen and blinds and sold separately.

Varnished pine frame comes pre-painted white.

Step flashing and underlayment sold separately.

See page 43 for sizes.

**Available in Triple Pane for enhanced energy efficiency.**



# In Stock FCM

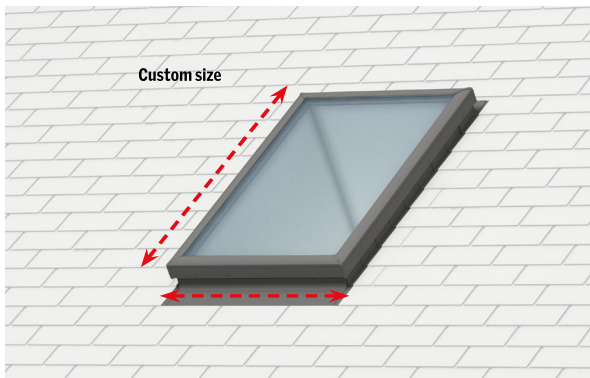

**Call VELUX**  
to check in stock  
custom sizing

## Fixed Curb Mounted Skylights

VELUX now stocks the 20 most ordered custom sized FCM skylights in our warehouse, ready to ship to site just like our standard sized products.

### How it works and the range of dimensions possible:

Think shoebox and shoebox lid.

The flashed curb mounted to the roof is the shoebox and our FCM skylight with the aluminum overhang is like the shoebox lid.

The lid just needs to fit, but the edge can be within 1/8" to the flashed curb, or looser up to 3/4".

This gives us the minimum and maximum clearance range, but still allows contact of the FCM's inner gasket to seal with the curb.



# Custom FCM

---



## Fixed Curb Mounted Skylights

Skylights available to fit curbs including flashing that have maximum clearance dimensions of up to 50  $\frac{3}{4}$ " x 76  $\frac{1}{2}$ ".

### Features

**Custom skylights are made to order. We also carry our most popular custom sizes in stock for faster delivery. Call VELUX to check in stock custom range.**

Available in CleanComfortPlus- Laminated glass (04 code).

Condensation weepage system on all four corners.

VELUX recommends a 5° slope for water drainage when installing on a flat roof.

Installation under 14° is not recommended where humidity or condensation is a concern.

Maintenance free exterior.

Blinds and flashing not available, call for options.



# Curb Mounted GSM - Skymax Custom Series

**GSM**  
**SkyMax**  
custom series up to  
**32 sq. ft.**  
Call to order



## Features

One-piece extruded vinyl curb incorporates a condensation channel.

Single unit up to 32 square feet- ten feet at the longest dimension.

Vinyl frame is structurally reinforced with aluminum.

Elimination of weep holes increases thermal performance.

Available in 12 designer colours.

Sizes are based upon the outside curb dimensions.

For use with site-built curb and flashing minimum 3 ½" curb.

# Flat Roof Skylights

## Quick and easy solution for skylights on a flat roof

The CurveTech skylight features an innovative curved-shaped glass surface that lets in more daylight, easily drains rainwater and stands out externally as a modern addition to roof surfaces.



### Features

Highly energy efficient, direct roof mount that brings large amounts of sunlight through a flat roof.

Double glazed window with protective curved-shaped glass or polycarbonate cover.

Protective cover keeps inner pane warmer reducing likelihood of condensation and minimizing sound from rain and hail.

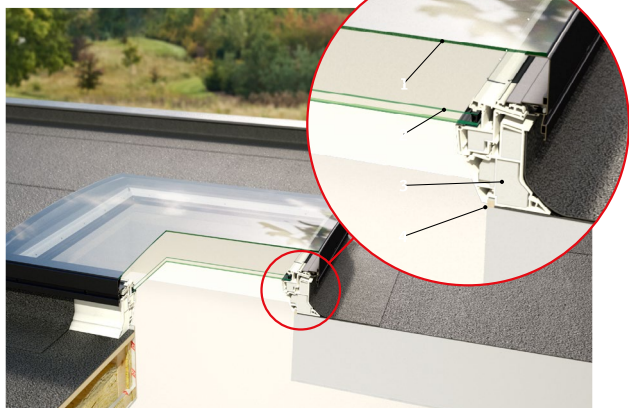

1. Curved-shaped glass cover for water drainage
2. Double glazed glass unit
3. Maintenance-free PVC curb with polystyrene insulation
4. Drywall groove for interior finish

# Curved Glass Skylight

## CFU + CurveTech

### Curved Glass Skylight – CFU + CurveTech

The new generation VELUX curved glass skylight is a revolution in flat roof skylight design. The unique design with a slim frame and invisible sash provides maximum daylight, triple glass base unit for **excellent energy efficiency** and a beautiful glass-to-edge view from inside the home. In addition, the curved-shaped glass top allows rainwater to easily drain off the surface – even on 0° roof pitches.

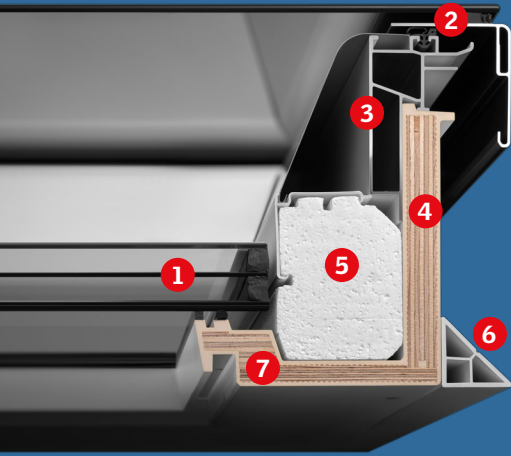

## CurveTech

- 1 Triple pane glazed unit with laminated inner pane for additional safety
- 2 Glass-to-edge top unit secured with sealants
- 3 Thin "sash"-like aluminum
- 4 Thin and elegant PU frame, more heat resistant than PVC
- 5 ThermoTechnology, heat resistant, UV-stable, contributes to energy-efficiency
- 6 PVC loose triangle/elephant foot for easy installation
- 7 Drywall groove for interior finish technology

## CFU - Generation Flat Roof Skylight



Clear view and drainage with CurveTech.  
Thin frame and sash for clear view to the sky.  
Excellent sound reduction.  
Skylight and protective cover will be shipped in 2 pieces.

## CVP – Flat roof manual venting skylight

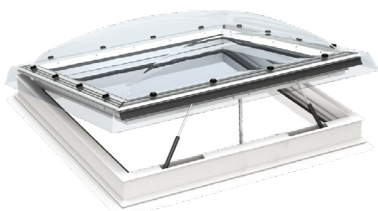

- PVC insulated curb included.
- Manual venting flat roof skylight includes control rod.
- Available as large as 4' x 4'.

## CXP - Flat roof exit



- PVC insulated curb included.
- Provides roof access to flat roofs.
- Sleek internal appearance with a 60° opening angle.
- Available as large as 4' x 4'.

## CFP – Flat roof skylight



PVC insulated curb included.  
Available as large as 5' x 5'.  
Solar blind options available.

VELUX  
Curb Mounted  
Skylights have  
been tested  
to perform  
on flat roofs.

# Skylight Accessories

---

## Home automation



### **KIX 300** – VELUX ACTIVE Indoor Climate Control Starter Kit

The sensor based control system monitors the climate in your home and automatically adjusts the ventilation of your skylights and position of your blinds for a healthier home. Includes Climate sensor, Departure switch and Internet gateway.

Backwards compatible with any solar or electric skylight manufactured after 2010.

Models: VSS, VCS, VSE, VCE

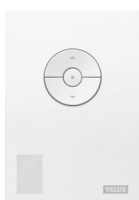

### **KLA 300** – VELUX Active Indoor Climate Sensor

Purchase an additional sensor for other rooms with VELUX operable skylights. For Solar and Electric Venting skylights.

Models: VSS, VCS, VSE, VCE



### **KIG 300** – VELUX Active Internet Gateway

Purchase an additional internet gateway to improve connectivity. For Solar and Electric Venting skylights.

Models: VSS, VCS, VSE, VCE

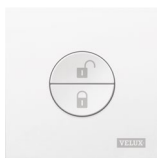

### **KLN 300** – VELUX Active Departure Switch

Purchase an additional departure switch for added convenience. For Solar and Electric Venting skylights.

Models: VSS, VCS, VSE, VCE



### **KLF 200** – Home automation integration kit

Provides two advanced functions: it acts as a repeater that extends the RF range for large spaces as well as an interface unit which allows operation via external systems in your home. For Solar and Electric Venting skylights.

Models: VSS, VSE, VCS, VCE



## Remotes and Electric



### **KLI 110** – Basic remote control

Simple operation of blinds. Operates wirelessly and can be wall mounted. Included with solar blinds for manual venting or fixed skylights.



### **KLB 100** – Battery backup

Allows limited operation of electric skylights during a power failure. One needed per applicable skylight.

Models: VSE, VCE

## Manual skylight and blind operation



### **ZZZ 203** – VS/VCM Angle Adaptor

Angle adaptor allows an easier operation on a steeper pitch.

Models VS, VCM



### Replacement Hook

Replacement hook to operate manual skylight with a chain operator that is installed overhead.

ZZZ 202 (VS)

ZZZ 211 (VCM)



### **ZCT 300** – 6' - 10' Telescopic rod

Telescopic rod to operate manual venting skylights with a smooth-turning operation. 3' extension available (ZCT 100).

Models: VS, VCM



### **Z0Z 032** – 2' Manual rod

A rod to operate manual venting skylights with a smooth-turning operation. 3' extension available (ZCT 100).

Models: VS, VCM



### **ZXT 200** – 3' - 6' Telescopic rod

Telescopic rod for operation of out of reach manual blinds. 3' extension available (ZCT 100).

Models: All skylight manual blinds.

# SUN TUNNEL® Skylight

## Transforming Spaces into Favourite Places

No structural changes to the home



After with two units

## How a SUN TUNNEL® Works

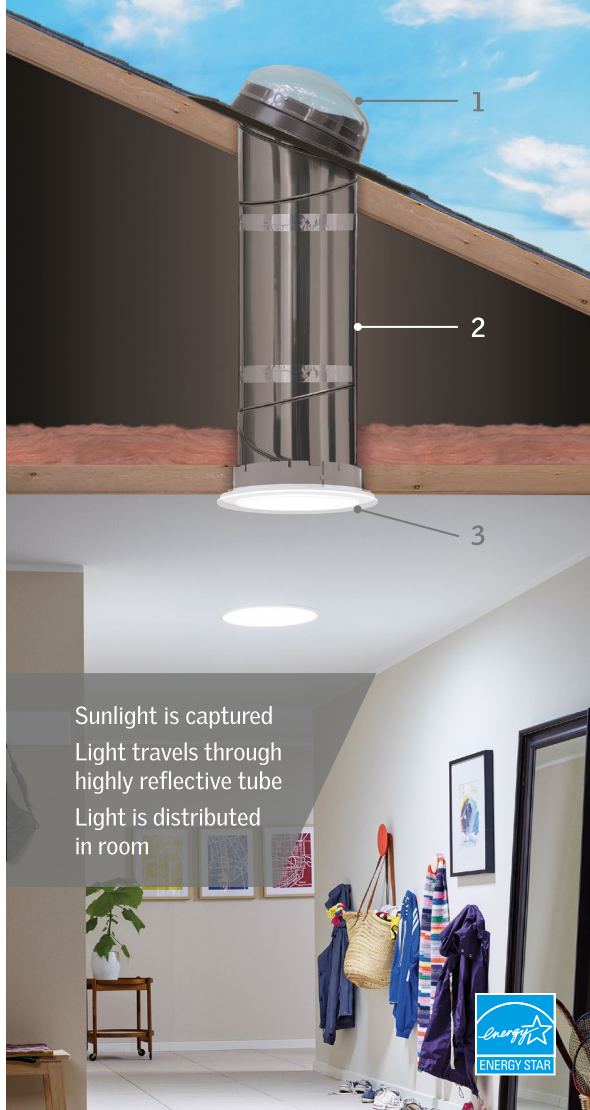

Sunlight is captured  
Light travels through  
highly reflective tube  
Light is distributed  
in room

### Features & Benefits

An energy efficient source of bright, natural light.

Ideal for projects where the distance between the roof and ceiling is too long for a traditional skylight.

Easier install with unique patented Flexi-Loc™ system.

20-year warranty for rigid tube reflection-enhanced material.

10-year warranty against manufacturer's defects, rust, corrosion and deterioration.

# SUN TUNNEL® Models

## Rigid Models – Maximum light output



**TMR**  
Rigid pitched  
flashing



**TGR**  
Rigid low  
profile flashing



**TLR**  
Flat glass  
flashing



**TCR**  
Flat roof  
flashing

Features a highly reflective tube that provides brighter natural light output. Ideal for straight runs with some flexibility, up to 90°.

Comes with 4' tube in box. Tubes can run up to 20' for 10" and 25' for 14".

TGR and TLR models recommended for south-facing roofs only.

Includes unique Flexi-Loc system, dual pivot elbows and pitch adaptor to cut installation time in half over older models.

**Provides the best light output.**



14° - 60°  
3:12 - 20:12

TCR only



0° - 30°  
0:12 - 7.5:12

### Flexi-Loc™ system



### Elbows and pitch adaptor

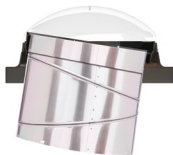

## Flexible Models



**TMF**  
Flexible pitched  
flashing



**TGF**  
Flexible low  
profile flashing



14° - 60°  
3:12 - 20:12

For installations with many attic obstructions

8' of tube included in 14" kit (8' max tube length)

8' of tube included in 22" kit (12' max tube length)

TGF model recommended for south-facing roofs only

# How to Choose Your SUN TUNNEL® Skylight

## Step 1: Pick your model by size and roofing

Available sizes

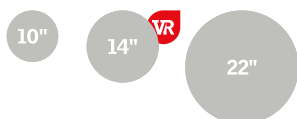

Roofing orientation

Roof Exposure	Light Coverage		
	< 150 sq. ft	150-200 sq. ft	200-325 sq. ft
All exposures	TMR 010 TMF 014	TMR 010/014 TMF 014	TMR 014
South exposures	TGR 010 TGF 014 TLR 014	TGR 010/014 TLR 014 TGF 014/022	TGR 014 TCC 022
Flat roof	TCR 014 TCC 022 (up to 400 sq. ft.)		

## Step 2: Determine quantity of SUN TUNNEL® needed

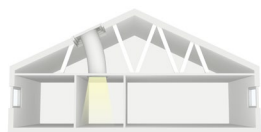

### Small/square spaces

If < 150 sq. ft 1 unit required  
If 200 sq. ft + consider rigid or multiple units

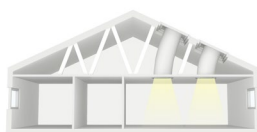

### Narrow/rectangular spaces

Consider multiple units

## Step 3: SUN TUNNEL® accessories



**ZTR** - Rigid tube extensions  
For longer tube runs 2', 4' and 6' tube extension pieces are available in 2' increments.

**ZTF** - Flexible tube extensions  
12' flexible tube replaces the standard 8' flexible tube.



### ZTC - Energy Kit

Contains a clear lower tube cap that increases the energy efficiency, providing an added layer of protection. Required to meet Energy Star



### ZTB - Decorative diffuser upgrade options

See page 43 for more diffuser options.



# VELUX Blind Collection

---

The ultimate control  
with the VELUX  
Blind Collection

VELUX Blinds are a great way to control the amount of light in the room while adding additional energy efficiency and privacy. Achieve your desired amount of daylight, soften the afternoon sun or block out the light for privacy and comfort. For colour selection see page 45.

## Blind operation



### Solar Powered Blinds

Solar blinds are powered by an internal battery, which is charged by the sun and does not require wiring at installation.

Operates with a simple touch pad or upgrade to VELUX ACTIVE for automatic control.

# Blind Options

---



## Room Darkening Blind (Double pleated)

Blocks most incoming light.  
Energy efficient, highly insulated design.  
Provides absolute privacy.  
Solar powered available for all skylights.  
Manual operation available for fixed skylights and roof windows.



## Light Filtering Blind (Single pleated)

Softens and diffuses incoming light.  
Provides privacy and light control.  
Solar powered available for all skylights.  
Manual operation available for fixed skylights and roof windows.



## Venetian Blind (Roof windows only)

Control both direction and amount of incoming light.  
Maintain view of outdoors.  
Moisture resistant.  
Manual operation only.



## Duo Blind (Roof windows only)

Combination blackout and single pleated blind.  
Combines total blackout with light diffusing in any ratio at any level on the window.  
Available in white/beige.  
Manual operation only.

# VELUX Blind Codes



## Deck Mounted - Blind codes

Skylight Models	VSS/ VSE/ VS	FS
Solar room darkening	FSCH	FSCD
Solar light filtering	FSLH	FSLD

## Curb Mounted - Blind codes

Skylight Models	VCS/ VCE/ VCM	FCM
Solar room darkening	FSCC	ZZZ+FSCC
Solar light filtering	FSLC	ZZZ+FSLC

■ Blind & blind tray shipped and invoiced individually.

## Flat Roof Skylights - Blind codes

Skylight Models	CFP
Solar room darkening	Special FSCH
Solar light filtering	Special FSLH









































Visit  
[veluxblinds.ca](http://veluxblinds.ca)  
for more  
information

## Deck Mounted Roof Window - Blind codes

Roof Window Models	GGL/ GPL/ GXL/ GDL
Solar room darkening - double pleated	Special FSCH
Solar light filtering - single pleated	Special FSLH
Manual venetian blind	PAL
Manual room darkening blind - double pleated	FHC
Manual light filtering blind - single pleated	FHL
Manual duo blind- beige/white	DFD

# VELUX Blind Collection

	Room Darkening	Light Filtering		Venetian	
Standard blind colours <sup>+</sup>	 1045 White	 1016 White	 7001 White		
Special order blind colours	 1047 Charcoal	 1049 Golden Beige	 1256 Classic White	 1259 Classic Sand	 7057 Brushed Silver
	 1155 Beige	 1156 Blue	 1274 Charcoal	 1275 Natural	 7062 Mat Black
	 1163 Grey	 1164 Grey Melange	 1276 Dusty Brown	 1277 Dusty Sand	 7063 Mat Grey
	 1165 Light Brown	 1166 Ivory	 1278 Beige	 1279 Red Wine	 7064 Natural
	 1167 Orange	 1168 Dusty Green	 1280 Forest Green	 1281 Mint Green	 7065 Taupe
	 1169 Light Blue	 1170 Dark Taupe	 1282 Dark Grey	 1283 Light Beige	
	 1171 Dark Sand	 1172 Light Grey	 1284 Grey	 1285 Soft Blue	
	 1173 Petrol		 1286 Blue Jeans		



# Sizes

## Deck Mounted Models

VSS – Solar Powered Venting Skylight

VSE – Electric Venting Skylight

VS – Manual Venting Skylight

FS – Fixed Skylight



	A06	C01	C04	C06	C08	C12	D26	D06	M02	M04	M06	M08	S01	S06
														
Rough opening (W" x H")	14 1/2 x 45 3/4	21 x 26 7/8	21 x 37 7/8	21 x 45 3/4	21 x 54 7/16	21 x 70 3/4	22 1/2 x 22 15/16	22 1/2 x 45 3/4	30 1/16 x 30	30 1/16 x 37 7/8	30 1/16 x 45 3/4	30 1/16 x 54 7/16	44 1/4 x 26 7/8	44 1/4 x 45 3/4
Outside frame (W" x H")	15 1/4 x 46 1/4	21 1/2 x 27 3/8	21 1/2 x 38 3/8	21 1/2 x 46 1/4	21 1/2 x 54 15/16	21 1/2 x 70 3/4	23 1/4 x 23 7/16	23 1/4 x 46 1/4	30 9/16 x 30 1/2	30 9/16 x 38 3/8	30 9/16 x 46 1/4	30 9/16 x 54 15/16	44 3/4 x 27 7/8	44 3/4 x 46 1/4

● VSS, VSE, VS & FS models only ● VSS, VS & FS models only ● FS models only



VELUX® Recommended



## Curb Mounted Models

VCS – Solar Powered Venting Skylight

VCE – Electric Venting Skylight

VCM – Manual Venting Skylight

FCM – Fixed Skylight (Can be installed sideways)



	1430	1446	2222	2230	2234	2246	2270	3030	3046	3434	3446	4622	4646	3055	3072	4672
 0° - 60° 0:12 - 20:12																
Rough opening (W" x H")	14-1/2 x 30 1/2	14-1/2 x 46 1/2	22-1/2 x 22 1/2	22-1/2 x 30 1/2	22-1/2 x 34 1/2	22-1/2 x 46 1/2	22-1/2 x 70 1/2	30 1/2 x 30 1/2	30 1/2 x 46 1/2	34 1/2 x 34 1/2	34 1/2 x 46 1/2	46 1/2 x 22 1/2	46 1/2 x 46 1/2	30 1/2 x 54 3/4	30 1/2 x 72 1/4	46 1/2 x 72 1/4
Outside curb (W" x H")	17-1/2 x 33 1/2	17-1/2 x 49 1/2	25-1/2 x 25 1/2	25-1/2 x 33 1/2	25-1/2 x 37 1/2	25-1/2 x 49 1/2	25-1/2 x 73 1/2	33 1/2 x 33 1/2	33 1/2 x 49 1/2	37 1/2 x 37 1/2	37 1/2 x 49 1/2	49 1/2 x 25 1/2	49 1/2 x 49 1/2	33 1/2 x 57 3/4	33 1/2 x 75 1/4	49 1/2 x 75 1/4
Maximum Skylight Clearance (W" x H")	18 5/8 x 34 5/8	18 5/8 x 50 5/8	26 5/8 x 26 5/8	26 5/8 x 34 5/8	26 5/8 x 38 5/8	26 5/8 x 50 5/8	26 5/8 x 74 5/8	34 5/8 x 34 5/8	34 5/8 x 50 5/8	38 5/8 x 38 5/8	38 5/8 x 50 5/8	50 5/8 x 26 5/8	50 5/8 x 50 5/8	34 3/4 x 59	34 3/4 x 76 1/2	50 3/4 x 76 1/2

● VCS, VCE, VCM, FCM models only ● VCS & FCM models only ● FCM models only

Custom sizes available to a maximum of 50 3/4" x 76 1/2", see page 28 for sizes. Call VELUX for details.



VELUX® Recommended

# Sizes

**GSM SkyMax** custom series up to **32 sq. ft.** Call for details.

## Custom FCM - Fixed curb Mounted



0° - 60° (0:12 - 20:12)

Maximum skylight clearance (inches)	18 ¾	19 - 26 ½	26 ¾	27 - 34 ½	34 ¾	35 - 38 ½	38 ¾	39 - 44 ¾	45 - 50 ½	50 ¾
18 ¾ - 26 ½	•	•	•	•	•	•	•	•	•	•
26 ¾	•	•	<b>FCM 2222</b>	•	•	•	<b>FCM 3422</b>	•	•	<b>FCM 4622</b>
27 - 34 ½	•	•	•	•	•	•	•	•	•	•
34 ¾	<b>FCM 1430</b>	•	<b>FCM 2230</b>	•	<b>FCM 3030</b>	•	•	•	•	<b>FCM 4630</b>
35 - 38 ½	•	•	•	•	•	•	•	•	•	•
38 ¾	•	•	<b>FCM 2234</b>	•	•	•	<b>FCM 3434</b>	•	•	•
39 - 44 ¾	•	•	•	•	•	•	•	•	•	•
45 - 50 ½ <sub>2w</sub>	•	•	•	•	•	•	•	•	•	•
50 ¾	<b>FCM 1446</b>	•	<b>FCM 2246</b>	•	<b>FCM 3046</b>	•	•	•	•	<b>FCM 4646</b>
51 - 55 ¼	•	•	•	•	•	•	•	•	•	•
55 ½ - 60 ¾	•	•	•	•	•	•	•	•	•	•
61 - 72	•	•	•	•	•	•	•	•	•	•
72 ¼ - 74 ½	•	•	•	•	•	•	•	•	•	•
74 ¾	•	•	<b>FCM 2270</b>	•	•	•	•	•	•	•
75 - 76 ½	•	•	•	•	•	•	•	•	•	•

All dimensions are maximum skylight clearance. Some building codes require use of CleanComfortPlus or CleanEnergyPlus glass. For pricing and additional sizing please call 1 800-888-3589.

# Made to Measure

Can be installed sideways for more size options

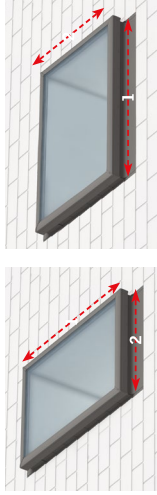

1. From 18¾" to a maximum of 76½"
2. From 18¾" to a maximum of 50¾"



# Sizes

## Flat Roof Models

CFP – Flat Roof Skylight

CFU – Curved Glass Skylight

CVP – Flat Roof Manual Venting Skylight

CXP – Flat Roof Exit

CFP



CFU











CVP



CXP



	 6060	 6090	 8080	 9090	 90120	 100100	 100150	 120120	 150150
Rough opening (W"xH")	60 x 60	60 x 90	80 x 80	90 x 90	90 x 120	100 x 100	100 x 150	120 x 120	150 x 150
Rough opening (W"xH")	23 <sup>5</sup> / <sub>8</sub> x 23 <sup>5</sup> / <sub>8</sub>	23 <sup>5</sup> / <sub>8</sub> x 35 <sup>7</sup> / <sub>16</sub>	31 <sup>1</sup> / <sub>2</sub> x 31 <sup>1</sup> / <sub>2</sub>	35 <sup>7</sup> / <sub>16</sub> x 35 <sup>7</sup> / <sub>16</sub>	35 <sup>7</sup> / <sub>16</sub> x 47 <sup>1</sup> / <sub>4</sub>	39 <sup>3</sup> / <sub>8</sub> x 39 <sup>3</sup> / <sub>8</sub>	39 <sup>3</sup> / <sub>8</sub> x 59	47 <sup>1</sup> / <sub>4</sub> x 47 <sup>1</sup> / <sub>4</sub>	59 x 59
Exterior frame (W"xH")	30 <sup>11</sup> / <sub>16</sub> x 30 <sup>11</sup> / <sub>16</sub>	30 <sup>11</sup> / <sub>16</sub> x 42 <sup>1</sup> / <sub>2</sub>	38 <sup>7</sup> / <sub>16</sub> x 38 <sup>9</sup> / <sub>16</sub>	42 <sup>1</sup> / <sub>2</sub> x 42 <sup>1</sup> / <sub>2</sub>	42 <sup>1</sup> / <sub>2</sub> x 54 <sup>5</sup> / <sub>16</sub>	46 <sup>7</sup> / <sub>16</sub> x 46 <sup>7</sup> / <sub>16</sub>	46 <sup>7</sup> / <sub>16</sub> x 66 <sup>1</sup> / <sub>8</sub>	54 <sup>5</sup> / <sub>16</sub> x 54 <sup>5</sup> / <sub>16</sub>	66 <sup>1</sup> / <sub>8</sub> x 66 <sup>1</sup> / <sub>8</sub>

# Limited Warranty Summary

---

This Warranty applies to products manufactured as of January 1<sup>st</sup>, 2010. Please contact VELUX for warranty information for product manufactured prior to 2010.

## VELUX® Skylights & Roof Windows

- 20 YEARS:** Parts on seal failure (moisture between glass panes).
- 10 YEARS:** Parts for defective skylights, roof windows and flashings.
- 10 YEARS:** Laminated glass with Neat® coating and triple pane products on cracking or breakage due to hail.

## VELUX® SUN TUNNEL® Skylights

- 20 YEARS:** Parts for rigid tube reflection-enhanced material (surface deterioration).
- 10 YEARS:** Parts (corrosion and deterioration).

## VELUX® Electrical Systems & Sunscreening Accessories

- 5 YEARS:** Parts for electrical systems and sunscreening accessories.

## VELUX® Commercial Warranty

See [velux.ca](http://velux.ca) for full warranty details.

Limited labour warranty included. See [velux.ca](http://velux.ca) or call for full warranty details.

Limited labour warranty included. See [velux.ca](http://velux.ca) or call for full warranty details.



# Energy Star

---



Canada has adopted a simple, single zone criteria for Energy Star rating.

VELUX has the best selection of Energy Star certified skylights and SUN TUNNEL® Skylights. Not only do we have products that meet Energy Star to save your clients money but they are all rigorously tested to perform in the harshest and most extreme climates.

All Energy Star® certified skylights are required to have a maximum U-factor value of 2.29 (metric) or 0.40 (imperial) and meet factory inspections. Energy Star® certified skylights are more energy efficient than what most local building codes require.

VELUX also has the **VELUX Energy Series**  with products that have extremely low performance U-values.

For more information on Energy Star visit [www.nrcan.gc.ca/energy](http://www.nrcan.gc.ca/energy)

**VELUX®** | The No Leak Skylight™

## Transforming Spaces into Favourite Places



Call or visit our website to be matched up with the right certified member of the **VELUX® Installers Program** in your area.

### Head Office

**VELUX®** Canada Inc.  
2740 Sherwood Heights Dr.  
Oakville, Ontario  
L6J 7V5

Phone: 1 800-888-3589

Fax: 1 800-898-3589

### Western Office

**VELUX®** Canada Inc.  
#2130 - 550 Sherling Place  
Port Coquitlam, BC  
V3B 0J6

Web: [velux.ca](http://velux.ca)

Email: [velux-cdn@velux.com](mailto:velux-cdn@velux.com)



**SUITABILITY:** Determining the suitability and compliance with local or other applicable building codes or standards, of all building components, including the use of any VELUX® products, and the design and installation of any flashing, is the responsibility of the buyer, user, architect, contractor, installer, and/or other construction professional. VELUX® will not be liable for any problem or damage relating to inappropriate or faulty building design or construction, maintenance, installation, or selection of products. Skylights, Roof Windows and SUN TUNNEL® Skylights are only one element of a structure; VELUX® does not warrant that third party certification of a building or project to any specific standard will be achieved through the use of any VELUX® product.

Contact VELUX® to discuss the best suited skylight for your application at 1 800-888-3589.

V-CDN-XCA-M-CBE-0123 ©2023 VELUX® GROUP. VELUX®, VELUX® LOGO ARE REGISTERED TRADEMARKS USED UNDER LICENSE BY THE VELUX® GROUP. SUN TUNNEL® IS A REGISTERED TRADEMARK USED UNDER LICENSE BY THE VELUX® GROUP.